

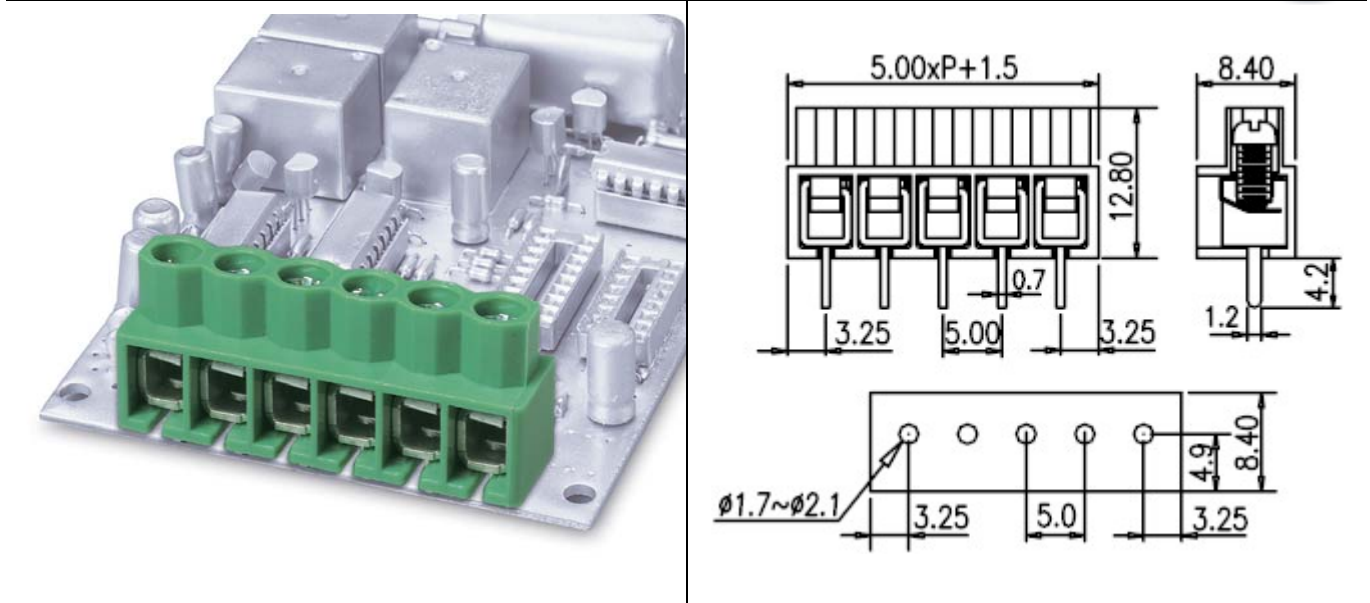



Wire protector type terminal blocks / 166 series



166



Pitch: 5.00mm

Approval	  	
Technical Data	UL	IEC
Rated voltage	300V	380V
Rated current	12A	16A
Wire range		4mm ²
Solid wire (AWG)	18~12	
Stranded wire (AWG/mm ²)	18~12	
Rated surge voltage (UL/IEC/Max.)	1.6 / 2.5 / 4 KV	
Torque (Lb-in)	3	
Screw	M3	
Wire strip length	6~7mm	
Pole	Cat. No.	
02	166-02P	
:	:	
:	:	
30	166-30P	

TEL: +886-2-2908-0614

FAX: +886-2-2908-8549

E-mail: infor@dinkle.com.tw